

have fun! learn about our city!

KIDS ACTIVITY BOOK

Georgia Cities Week 2022:
Connecting for Success



City of Decatur®

all about our city logo



City of Decatur®

The city logo, launched in 1984, stands for "A city of homes, schools and places of worship." Its nine colors are used throughout this booklet.

Any organization besides the city wishing to use the city logo must have approval from the city commission. Contact Linda Harris, 678-553-6512, or linda.harris@decaturga.com.

about this booklet

This activity book, designed for school-age children, is filled with information about city services. We hope you learn about our city and have fun at the same time. For additional copies or to make suggestions for next year's Kids Activity Book, please contact decaturfocus@decaturga.com or call 404-371-8386.

Georgia Cities Week is April 24-30. Each city designs its own programs to highlight city services and activities. Decatur celebrates with this special Kids Activity Book.

©2022 City of Decatur, Georgia
Design and illustrations by
Lampe-Farley.com

a big thank-you!

...to our
Decatur
Youth
Council
guest
contri-
butors!



Ana

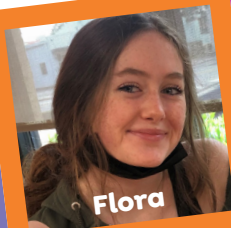

Flora



Bahiyyih

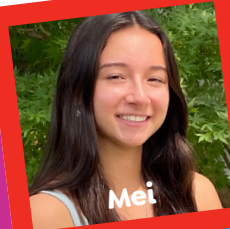

Mei



Lee Rachel



Molly



Qaden



Sage



Salmoncain



Miles



Lily



Ivie



Henry



William



Robert



Not
pictured:
Sammy

what is the NYC?

It's a volunteer advisory board open to high school students in Decatur. Find out more at decaturga.com/dnc.



what will you be?

some day, YOU could work for the City of Decatur!

Here are six examples of city careers. Check off the skills and attributes that match your interests and abilities. Tally up your score to see which Decatur career might be in your future!

Police Officer

Skills, attributes needed:

- Problem solver
- Fact / clue finder
- Lots of patience
- Quick thinker
- Likes to work outside

total: _____

Digital Media Specialist

Skills, attributes needed:

- Tech savvy
- Loves social media
- Knows digital trends
- Creative
- Detail oriented
- Communicates well on digital platforms

total: _____

Operations Analyst

Skills, attributes needed:

- Communication
- Compassion
- Accounting
- Detail oriented
- Listen to others

total: _____

Chief Clerk/Court Administrator

Skills, attributes needed:

- Active learning
- Problem solving
- Attention to detail
- Time management
- Service orientation

total: _____

City Manager

Skills, attributes needed:

- Problem solver
- Listener
- Empathetic
- Humility
- Creativity

total: _____

Mayor of Decatur

Skills, attributes needed:

- Positivity
- Integrity
- Vision
- Collaboration
- Active listening

total: _____

what's your top job?

Want to invite a city employee to speak to your student group about a particular career path? Interested in an internship or "shadowing" opportunity? Contact hr@decaturga.com



recycling reset

You can recycle any of the items shown here, including soiled pizza boxes!

Draw arrows to connect each group of empties to the appropriate recycling bin.



need some hints?

GREEN BINS for clean paper, cardboard, cans, cartons and plastic bottles.

RED BINS for clean, rinsed glass bottles and jars.

Recycling reminder



DON'T BAG RECYCLABLES



NO PLASTIC BAGS OR PLASTIC WRAP



NO FOAM PRODUCTS



NO CERAMICS CUPS, PLATES, BOWLS, ETC.



NO CLOTHES OR TEXTILES



connecting with waterways

what is the eastern subcontinental divide?

It's a land ridge that runs right through the middle of Decatur! Rain that falls east and south of the divide flows into the Atlantic Ocean, and rain that falls west and north of the divide flows into the Gulf of Mexico.

What side of the divide do you live on? Atlantic Gulf of Mexico

Is there a creek near you? Where does it flow? Atlantic Gulf of Mexico

Put a big dot where you live!



pick a camp, any camp

1



cut-cut-cut

2

Fold on the dotted lines!

Bandstand Blue	 Camp Popstar	 Hoop it Up	Oakhurst Orange
 Superhero Bash	Discover more about all the summer camps at decaturga.com/playbook!		 Cooking with Friends
 Soccer Camp			 The Party Planner
Ponce de Leon purple	 Bike Camp	 Tennis Camp	McDonough St. magenta

Need help folding? Check decaturga.com/kidsactivitybook.



6

design a kid-friendly shop

Draw your items in the window, and put your shop name in the sign space. Bring your drawing to the Decatur Visitors Center at 113 Clairmont Ave. and get a special prize!

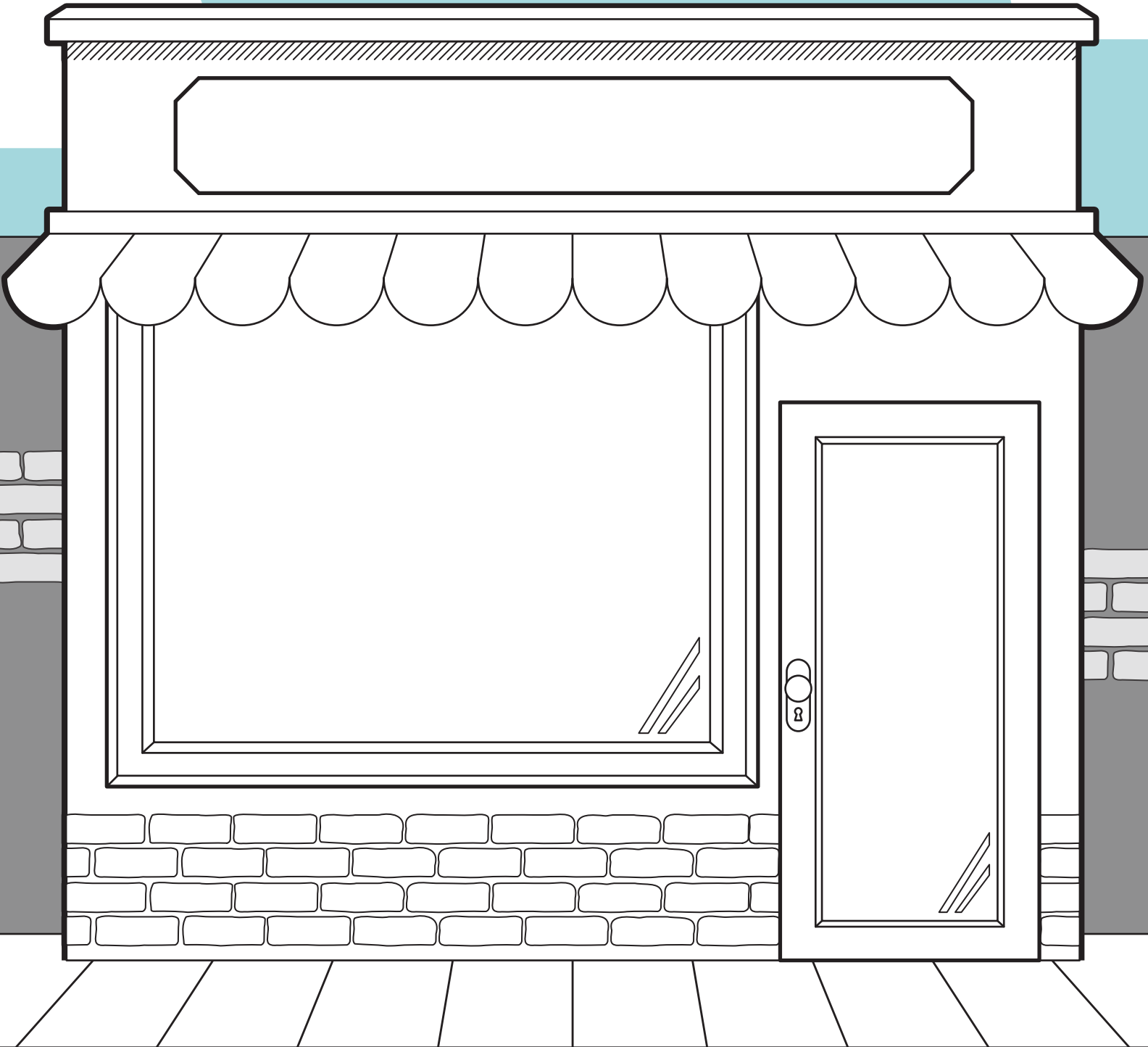

connect with art around town

Decatur has outdoor sculptures all over town. The newest addition to the city's collection is What Sonia Said, unveiled to the public in 2021. Connect the dots to reveal them here, and then grab a grownup and walk or roll to see them for yourself.

Celebration

by Gary Price

Installed: 2000

Dedicated to
Mayor Emerita
Elizabeth Wilson

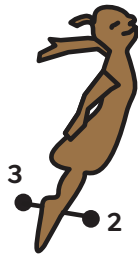
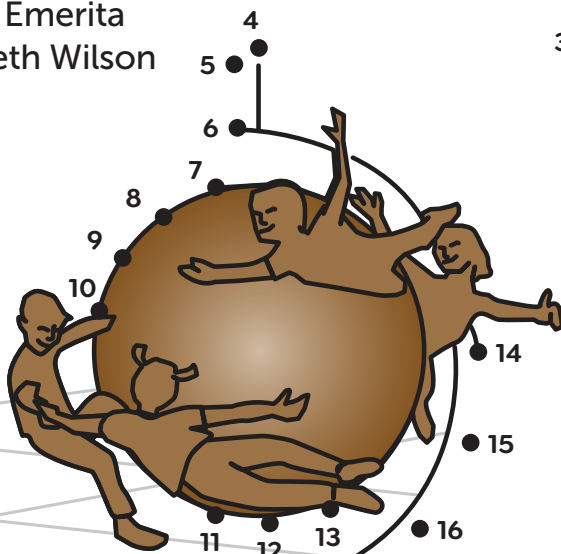

Look for this sculpture on the plaza downtown. In warm months it's a fog fountain!

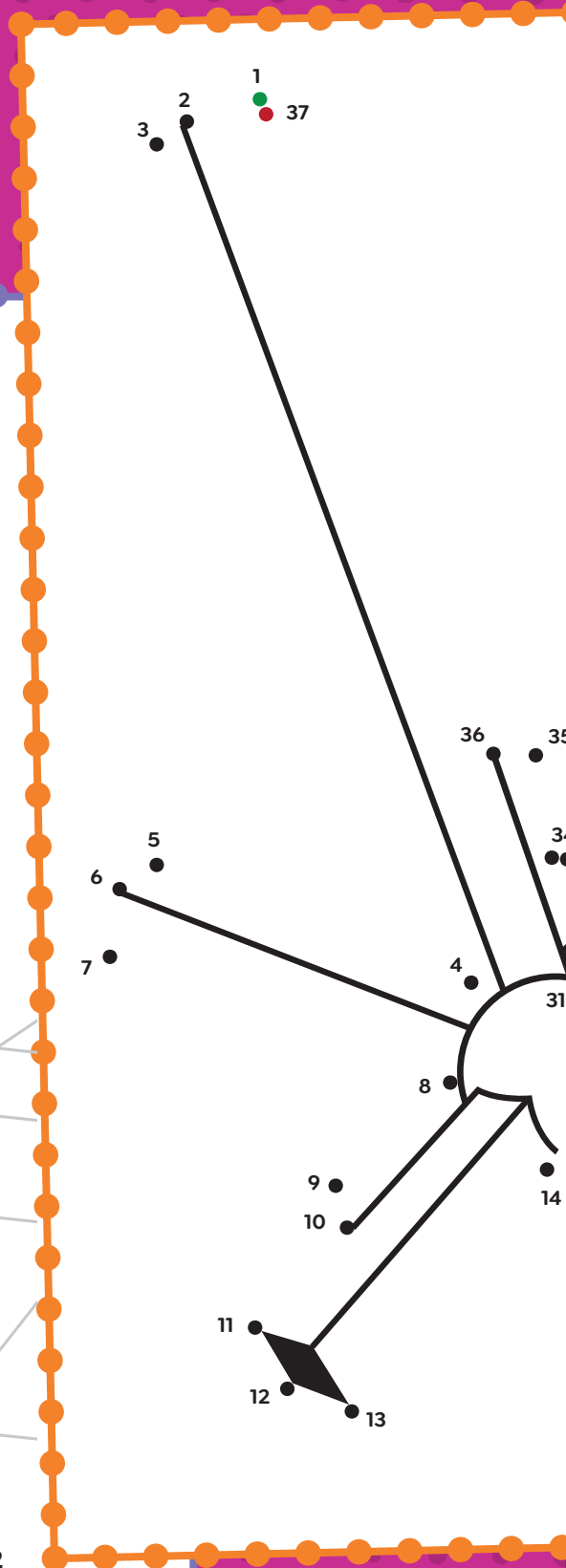
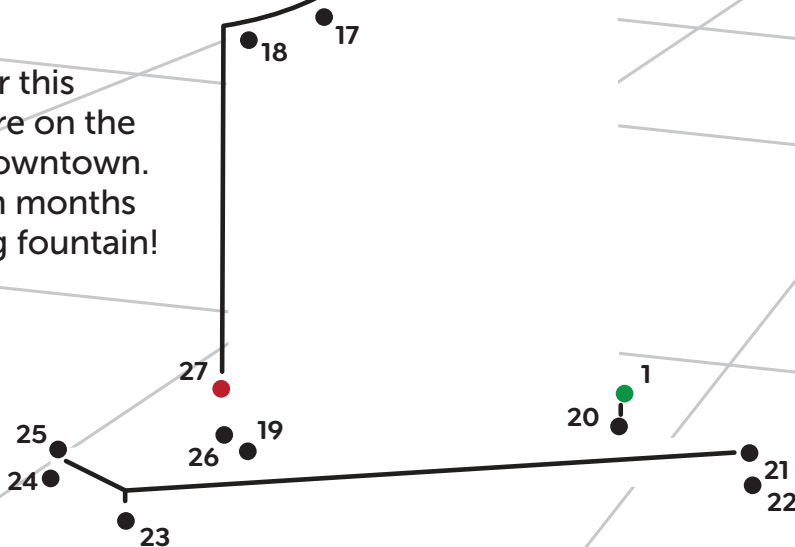

Dreamsicle by Nathan Pierce

Installed: 2016

A kid-favorite sculpture
in Harmony Park,
Oakhurst Village

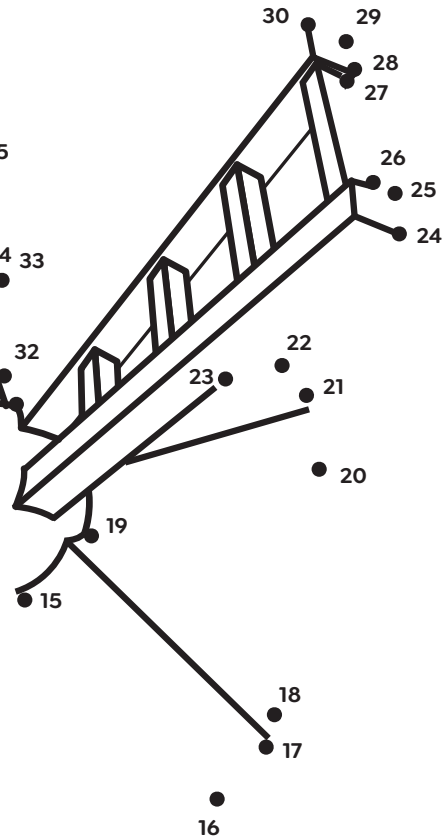

What Sonia Said

by Ellex Swavoni

Installed: 2021

Find this on the lawn
at the Beacon
Municipal Center at
420 W. Trinity Place

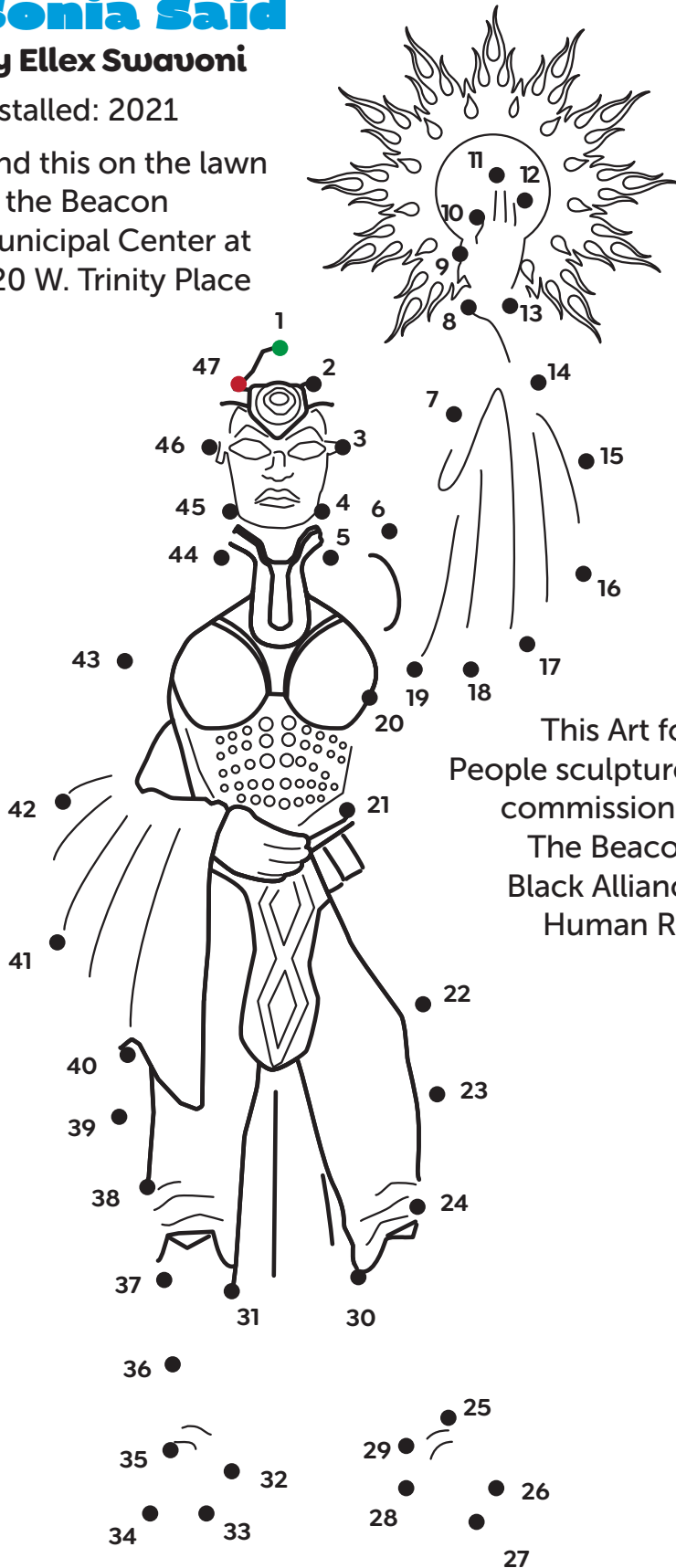

This Art for the
People sculpture was
commissioned by
The Beacon Hill
Black Alliance for
Human Rights.



touch-a-truck + touch-a-budget

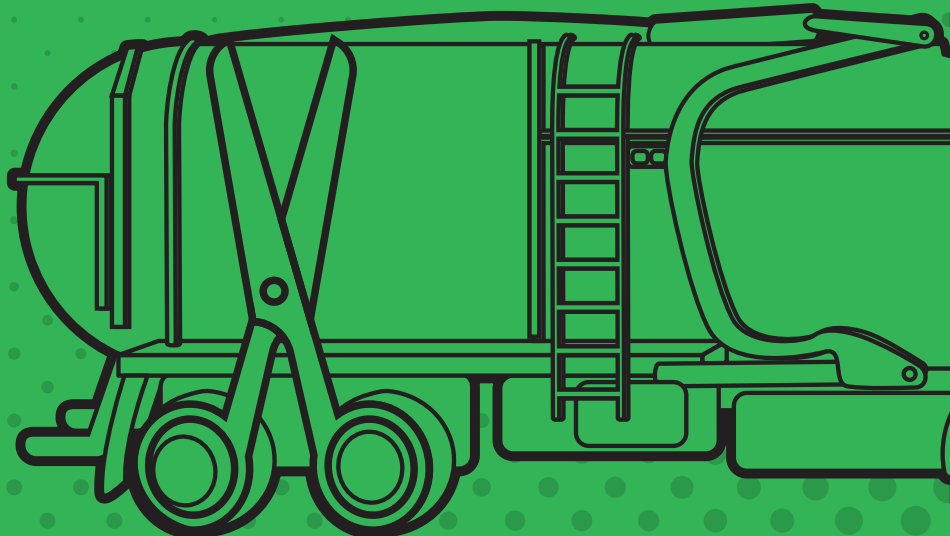
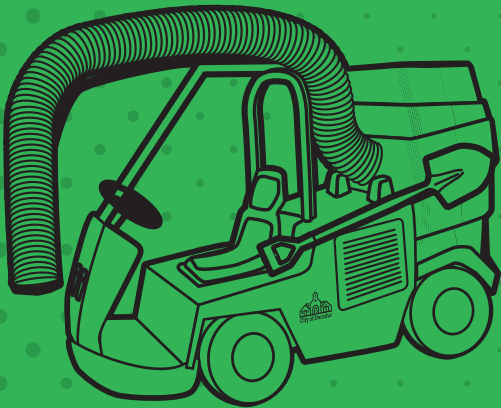
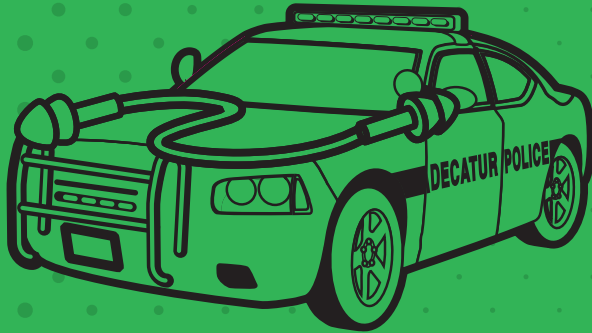
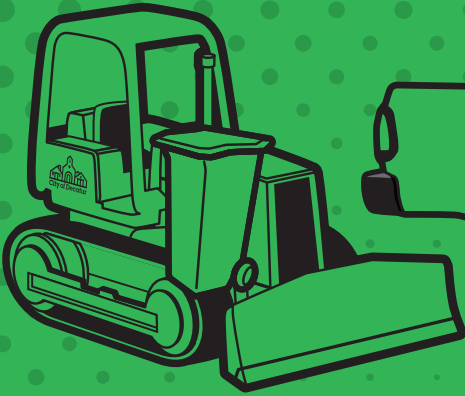

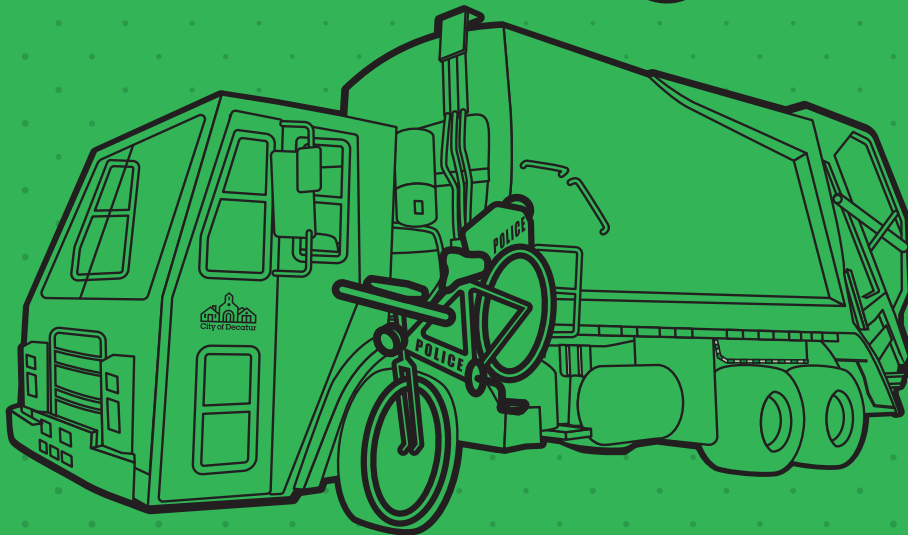
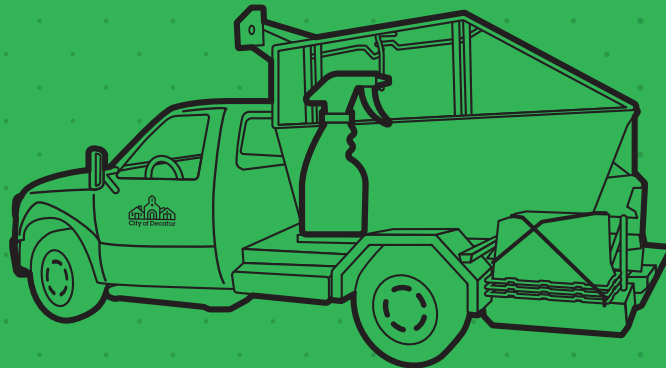

Here are 15 city vehicles you can see (and touch) at the touch-a-truck event. Look closely at each one and find these 15 items that the city might buy with the annual budget:

- Firefighter helmet
- Police bike
- Shovel
- Fire extinguisher
- Safety cone
- Street light
- Trash receptacle
- Scissors
- Computer
- Ear protection
- Spray cleaner
- Hammer
- Basketball
- Mobile phone
- Saw

trees scavenger hunt

How many of these tree species can you find in Decatur?



Dogwood

Where?



Sycamore

Where?



White oak

Where?



Maple

Where?



Tulip poplar

Where?



Red bud

Where?



Decatur turns 200 on December 10, 2023. Plant a tree as a birthday gift!

Have you planted a **Bicentennial Tree?**

Contact the city arborist, Kay Evanovich, kay.evanovich@decaturga.com, for more information.





public safety magic book



cut-cut-cut

Fill out, cut out, and fold up this handy little book for a ready reference in case of emergency.

fold on dotted lines and cut a slit in the middle

<p>personal information</p> <p>FIRST AND LAST NAME _____</p> <p>DATE OF BIRTH _____</p> <p>ALLERGIES / MEDICATIONS _____</p>	<p>home address</p> <p>ADDRESS _____</p> <p>draw your home! </p>	<p>parent/guardian #1 information</p> <p>FIRST AND LAST NAME _____</p> <p>PHONE NUMBER 1 _____</p> <p>PHONE NUMBER 2 _____</p>	<p>parent/guardian #2 information</p> <p>FIRST AND LAST NAME _____</p> <p>PHONE NUMBER 1 _____</p> <p>PHONE NUMBER 2 _____</p>	<p>MY SAFETY PASSPORT</p> <p>draw yourself! </p> <p>YOUR NAME _____</p>	<p>smart911 in decatur</p> <p> City of Decatur®</p> <p>call 911 IN AN EMERGENCY</p> <p>404-373-6551 POLICE (NON-EMERGENCY)</p> <p>404-373-5092 FIRE (NON-EMERGENCY)</p>	<p>emergency contact a friend or family member you trust</p> <p>FIRST AND LAST NAME _____</p> <p>PHONE NUMBER _____</p> <p>RELATIONSHIP _____</p>	<p>Smart911.com</p> <p>Go to smart911.com with your parents to set up a special safety account for your family.</p>
---	---	---	---	---	---	--	---

this will be the front cover!

Need help folding? Check decaturga.com/kidsactivitybook.



a budget tree

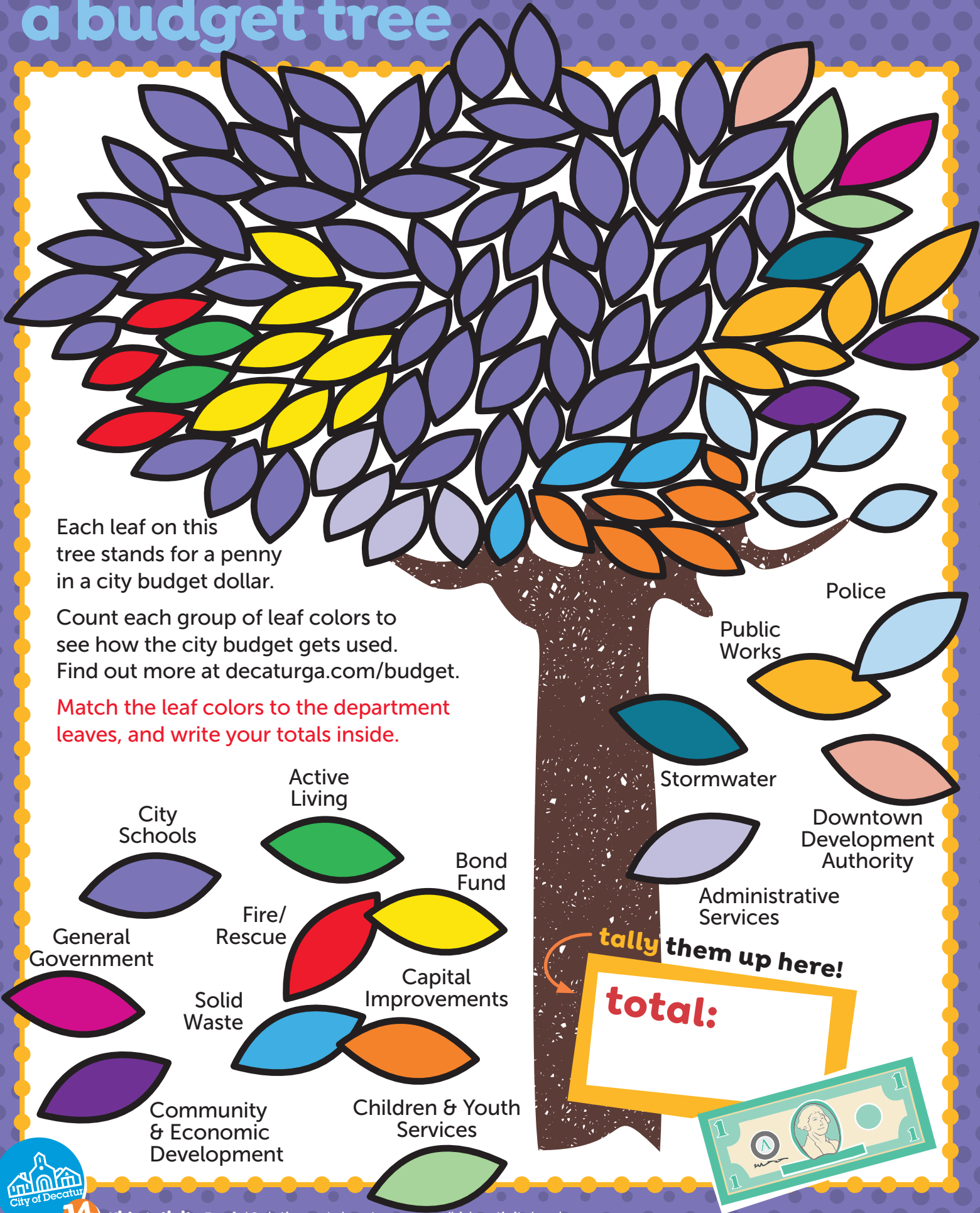

Each leaf on this tree stands for a penny in a city budget dollar.

Count each group of leaf colors to see how the city budget gets used. Find out more at decaturga.com/budget.

Match the leaf colors to the department leaves, and write your totals inside.

City Schools

Active Living

Bond Fund

Police

Public Works

Stormwater

Downtown Development Authority

Administrative Services

General Government

Fire/Rescue

Capital Improvements

tally them up here!

total:

Solid Waste

Children & Youth Services

Community & Economic Development

commissioners' park picks

Our city commissioners love Decatur parks –
unscramble the words to reveal their favorites

Mayor Pro Tem
Tony Powers

At-Large
Commissioner



(YCAGEL)

Mayor
Patti
Garrett

District 2
Commissioner



(GELLNKA E)

Commissioner
Kelly Walsh
District 1



(WODOALDNS)

Commissioner
Lesa Meyer
District 2



Commissioner
George Dusenbury
District 1



(HTE RQUASE)

(MONYHAR)

**what skills does a
City Commissioner need?**

Take the quiz on page 3
to see if the job of mayor
would be a good match for you!

There are five City Commission seats,
with two commissioners for each of
Decatur's two districts plus one at-large
commissioner.

Important skills and attributes include
integrity, flexibility, empathy, curiosity,
active listening, cooperation, stamina,
and even a sense of humor!

connect with streets

Fill in the names of these major streets in Decatur. Each circle represents a missing letter

Letters are filled in where the street names intersect. Refer to the street key at bottom.



street key

- Church Street • Clairemont Avenue • E. College Avenue • W. College Avenue
- S. Columbia Drive • Commerce Drive • East Lake Drive • Howard Street • Kirk Road
- S. McDonough Street • Oakview Road • E. Ponce de Leon Avenue • W. Ponce de Leon Avenue
- Sycamore Street • S. Candler Street • Scott Boulevard • W. Trinity Place